



New 125-Volt Fast Pulse Amplifier

IN nuclear radiation work the use of improved radiation detectors has brought about a general need for amplifying short pulses—some as short as 0.01 microsecond. In other fields, also, short pulses are becoming increasingly important. The -hp- Model 460A Wide Band Amplifier described earlier¹ is capable of amplifying such short pulses without introducing over-shoot distortion and was designed with sufficient output to operate scalars, counting meters, etc.

In pulse work, however, as elsewhere, it is desirable to be able to view on a cathode-ray tube the wave forms employed, but convenient viewing of pulses requires a pulse voltage much higher than that necessary for operating equipment such as scalars. The new -hp- Model 460B shown in Figure 2 is designed for a maximum output level of 125 volts open circuit—high enough to give more than full deflection on the type 5XP- cathode-ray tube or a 2-inch deflection on a type

5CP- tube. The other important characteristics of the new amplifier are those necessary for distortionless amplification of fast pulses, namely, a short rise time combined with zero overshoot.

The high output voltage is obtained with standard receiving tubes by designing the amplifier primarily to amplify pulses of a single polarity. Thus, the Model 460B amplifies positive pulses to a maximum level of 125 volts open circuit, while negative pulses can be amplified to a maximum level of 16 volts open circuit. A phase inversion occurs within the amplifier so that an applied pulse of positive polarity is discharged by the amplifier at a negative polarity. However, either upward or downward deflection can be obtained on a cathode-ray tube, depending upon whether the upper or lower deflecting-plate is connected to the ground terminal of the 460B.

¹N. B. Schrock, *A New Amplifier for Milli-Microsecond Pulses*, Hewlett-Packard Journal, Vol. 1, No. 1, Sept., 1949.

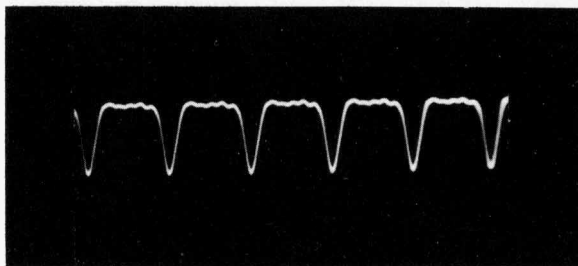

Through -hp- Model 460B
(a)

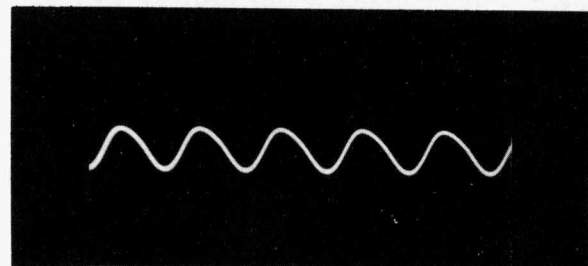

Through 12-mc video amplifier
(b)

Figure 1. Comparison of 10-megacycle triggering pulses when passed through conventional wide-band video amplifier and through -hp- Model 460B.

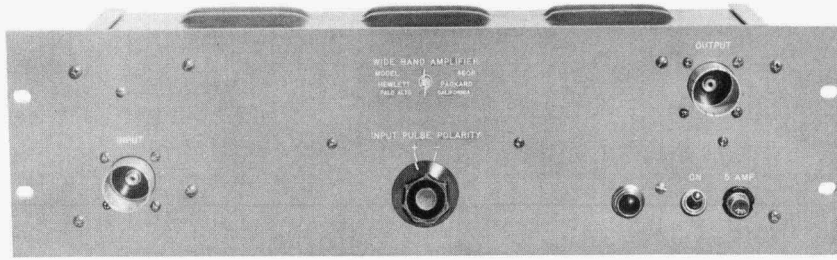

Figure 2. Panel view of -hp- Model 460B amplifier.

CIRCUIT DESCRIPTION

The extremely rapid rise time of the Model 460 amplifiers is obtained through the use of the circuit known as the distributed amplifier.² Briefly, the fundamental circuit can be described with reference to Figure 3. Here, the tubes are connected at fixed intervals between two artificial transmission lines that have equal propagation velocities. A signal applied to the input terminals passes down the grid line, exciting the grids. The resulting plate currents flow down the plate line, half in one direction and half in the other. Since the paths from the input terminals through any tube to the output terminals are the same length in terms of line sections traversed, the individual plate currents will arrive at the output termination all at the same time, thus adding together in the load to give a useful output. The currents flowing to the reverse plate termination are absorbed without reflection.

The input and output capacities of the tubes are used as elements in the grid and plate transmission lines. Hence, the tubes in the distributed amplifier are used in such a way that their plate currents add together while their capacities are used as transmission line elements. The distributed amplifier, then, overcomes the limitation of the standard gain-band-width product and it is possible to obtain band widths far in excess of 100 mc at gains much higher than unity.

OUTPUT VOLTAGE CONSIDERATIONS

The output voltage from a single stage of the distributed amplifier when operating into a matched load is $n i_p Z_p / 2$, where n is the number of tubes in the stage, i_p the plate current, and Z_p the plate line impedance. When gain is the primary consideration, it is most efficient to design a distributed amplifier stage to have a gain of ϵ or 2.7. Thus, the Model 460A consists of two stages having a gain of about 10 db each. However, when high output voltage is the primary consideration, as in the case of the Model 460B, a larger number of tubes per stage must be used regardless of gain efficiency. In the Model 460B, thirteen 6AK5 tubes are used in a single stage.

The number of tubes that can be used in a stage is limited by grid loading, which occurs at high frequencies because of the increased input conductance of the amplifier tubes. As the number of tubes is increased, the high-frequency attenuation of the signal as it travels down the grid line is increased, thereby

reducing the high-frequency gain and in effect restricting the frequency range of the amplifier. The thirteen tubes used in the single stage of the Model 460B represent a practical compromise between tube quantity and grid attenuation.

In order to obtain additional output voltage, the amplifier tubes in the Model 460B are operated at higher than normal supply voltages, the bias being increased to keep tube dissipation within ratings. By using a 300-volt supply for plate and screen and a bias of about 9 volts, a maximum negative output pulse of about 125 volts open circuit is obtained for a positive input pulse of about 8 volts. This high output is obtained at the expense of linearity – not a serious matter in pulse work.

Because of the high supply voltages, unusually large duty cycles will result in excessive tube dissipation. Rated tube dissipation is reached with an 8-volt positive driving pulse at a duty cycle of 10%. Lower driving voltages will allow the use of correspondingly higher duty cycles.

A panel switch can be used to change the supply voltages to normal values, allowing either positive or negative outputs of about 8 volts into 200 ohms. Thus, one Model 460B can be used in the normal position to drive a second Model 460B operating in the high negative output condition.

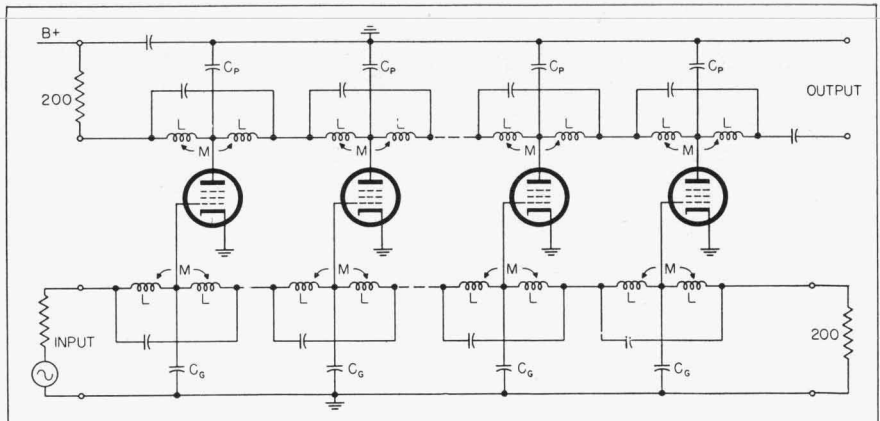

Figure 3. Basic amplifier stage.

²Ginzton, Hewlett, et al, *Distributed Amplification*, Proc. I.R.E., Vol. 36, August, 1949.

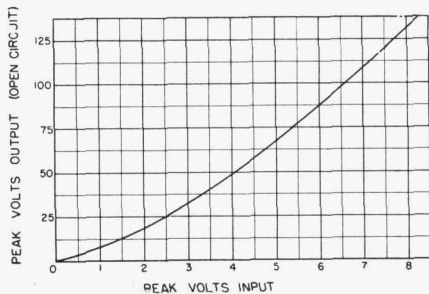

Figure 4. Linearity characteristic of typical -hp- Model 460B Amplifier.

LINE IMPEDANCE CONSIDERATIONS

The impedance of the grid line is of importance from the standpoint of convenience in inter-connecting amplifiers, since the grid line impedance is the input impedance of the amplifier. In both the Model 460A and 460B, the grid line impedance was chosen as 200 ohms—the highest impedance obtainable in a commercial coaxial cable.

The impedance of the plate line would normally be higher than the grid line, because the plate capacities of the tubes are smaller than the grid capacities. Thus, in the Model 460A, the plate line impedance is about 300 ohms. This higher value causes no undesirable effects even though the plate line is connected to a 200-ohm cable, because the 200-ohm cable is always terminated by a 200-ohm grid line when amplifiers are cascaded. The advantage of the higher plate line impedance is that about a 3 db improvement in gain is ob-

tained over an amplifier whose plate capacities are increased so as to give identical plate and grid lines.

On the other hand, the high output Model 460B amplifier normally will not be used to drive a 200-ohm load. Rather, it will be connected through a 200-ohm cable to a high impedance in many cases, thus giving double output voltage. The plate capacities in the Model 460B have therefore been loaded to be equal to the grid capacities and the output impedance has been made 200 ohms. Improved measuring techniques³ have allowed a flatter line than heretofore, and in a typical amplifier the output impedance is constant within approximately 5% over the amplifier's pass band. Thus, maximum flexibility is achieved, for the amplifier output can be connected through any length of 200-ohm coaxial cable to any arbitrary load with negligible secondary reflections from the amplifier.

The Gaussian response is obtained by designing the individual line sections with a bridged-T configuration that is obtained by using negative mutual inductive coupling between the coils in each section and by bridging a capacity across each section. The response of this configuration can be made quite similar to

³Arthur Fong, *Direct Measurement of Impedance in the 50-500 Mc Range*, Hewlett-Packard Journal, Vol. 1, No. 8, April, 1950.

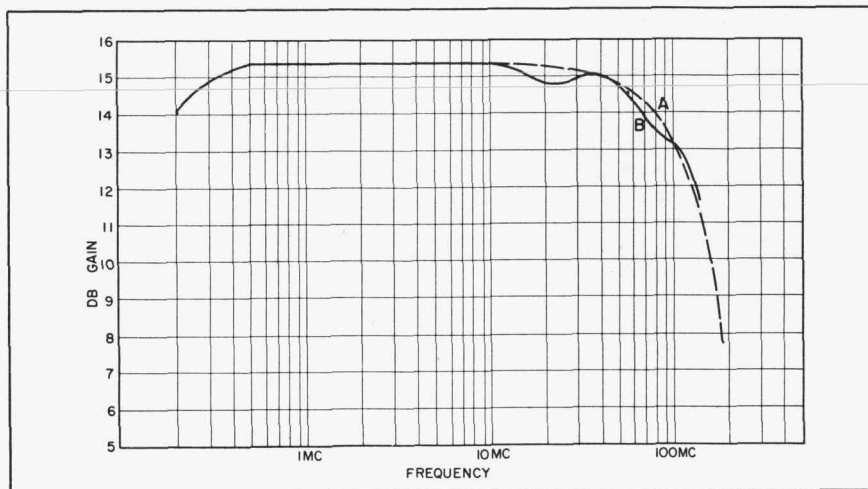

Figure 5. (a) Gaussian Response, (b) response of typical Model 460B amplifier.

the Gaussian response as can be seen in the overall amplifier response curve shown in Figure 5.

VERIFICATION TESTS

The rise-time of the Model 460B amplifier was proved by a method similar to that used with the Model 460A. This involved generating a very short pulse—0.01 microsecond—by means of a special pulse generator. Although the pulse generator itself was capable of generating pulses with rapid rise and decay and with a flat top, the RC time constant of the loaded 200-ohm amplifier in combination with approximately 5 mmf of capacity in the deflection plates limits the obtainable rise time to approximately 0.001 microsecond. The actual driving pulse, then, can be considered to have a rise time of approximately 0.001 microsecond and appears as shown in Figure 6(a) when passed through one amplifier.

In Figure 6(b) is shown a .02 microsecond pulse amplified by three Model 460 amplifiers in cascade. By measuring the rise time in oscillograms similar to these, the rise time of a single amplifier was calculated to be approximately .0026 microsecond.

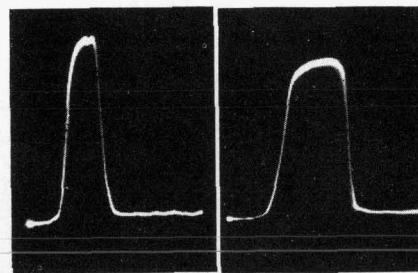

(a) 0.01 microsecond (b) 0.02 microsecond. Figure 6.

APPLICATION DATA

The -hp- Model 460B was designed principally as an external wide-band pulse amplifier for the vertical deflecting-plates of a cathode-ray tube. One or more 460B amplifiers can be cascaded with one or more 460A amplifiers without impairing the Gaussian response to give a high-gain "vertical" pulse amplifier having very rapid rise time

and high voltage output. Popular high-sensitivity cathode-ray tubes such as the 5CP- and 5XP- types have vertical deflection sensitivities ranging from approximately 25 volts per inch for relatively low accelerating voltages to approximately 80 volts per inch for high accelerating voltages. Thus, the 125-volt maximum output from the 460B will provide ample deflection for nearly any application.

When cascading amplifiers, consideration must be given to the polarity as well as the amplitude of the pulse to be amplified. For maximum deflection, the set-up must be arranged so that the input to the last amplifier is positive and of approximately 8 volts peak amplitude. This can easily be done because the Model 460B, unlike the Model 460A, consists of a single stage and will therefore invert the polarity of the applied pulse. Hence, an additional Model 460B can be used when necessary to invert pulse polarity. In most applications, a satisfactorily large deflection can be obtained with a driving voltage of less than 8 volts. For example, a 4-volt positive pulse applied to the last Model 460B in a chain will usually give a $\frac{3}{4}$ -inch or more deflection.

The rise time of amplifiers in cascade is greater than that of a single amplifier in accordance with the relation $T(n)^{1/2}$, where n is the number of 460 amplifiers in the system and T is equal to 2.6×10^{-9} seconds, the rise time of a single 460A or 460B amplifier. In addition to the rise time of the amplifiers, the rise

time of the RC combination formed by the capacity of the deflection plates and the internal impedance of the 460B (200 ohms) should be considered. The rise time of a type 5XP-tube driven from a 200-ohm source is approximately 2×10^{-9} seconds. The rise time of a type 5CP-tube is ordinarily several times that of the 5XP-, and the full capabilities of the amplifier will be realized only with a 5XP-tube. The following table gives the approximate rise time in millimicroseconds for various combinations of 460 amplifiers with the type 5XP-tube.

NUMBER OF AMPLIFIERS IN CASCADE	RISE TIME WITH 5XP-TUBE
1	3.2
2	4.1
3	4.8
4	5.5
5	6.1

ADAPTERS AND ACCESSORIES

The input and output connections on the 460 amplifiers are specially designed to be used with 200-ohm flexible cable. Such cable can be supplied with connectors in convenient patch cord form as well as in bulk.

Two adapters have also been designed to facilitate use of the 460B amplifier with cathode-ray tubes. Adapter 46A-95F, for use with the 5XP-tube, mounts on the neck of the crt shield and connects the output cable from the 460B to the vertical deflecting plates. The adapter can be connected so that a negative output pulse from the 460B will give either an upward or downward deflection on the tube.

The second adapter, 46A-95G in-

cludes a special terminal plate with banana plugs to connect the output cable from the 460B to the deflecting-plate terminals provided on current models of the Tektronix type 511 oscilloscope, which uses a 5CP-tube. Adapters for other oscilloscopes are being developed and will be available soon. —N. B. Schrock

SPECIFICATIONS FOR -hp- MODEL 460B WIDE BAND AMPLIFIER

FREQUENCY RESPONSE: High frequency response closely matches Gaussian curve. High frequency 3-db point is approximately 140 mc. Low frequency 3-db point is approximately 50 kc when operating into 200-ohm load. Lower frequency response available on special order.

MAXIMUM OUTPUT VOLTAGE: In high bias condition, approximately 125 volts peak negative open circuit for positive driving pulse of 8 volts peak; in normal bias condition, approximately 8 volts peak into 200-ohm load or 16 volts peak open circuit for either positive or negative pulses.

GAIN: Approximately 15 db into 200-ohm load.

INPUT IMPEDANCE: Approximately 200 ohms.

RISE TIME: Approximately 0.0026 microsecond.

DELAY: Approximately 0.016 microsecond.

DUTY CYCLE: .10 maximum for 125-volt output pulse; higher duty cycles can be used at lower output voltages.

LINEARITY: Similar to curve shown in Figure 4.

MOUNTING: Relay rack. 5 $\frac{1}{4}$ " x 19" panel, 6" deep.

POWER SUPPLY: Operates from nominal 115-volt, 50/60 cycle supply. Requires approximately 35 watts.

WEIGHT: 15 lbs.; shipping weight 28 lbs.

PRICE: \$225.00 f.o.b. Palo Alto, California.

ACCESSORIES

No. 46A-16A PATCH CORD: Special 200-ohm cable two feet in length, complete with two No. 46A-95B Cable Plugs; for interconnecting two amplifiers in cascade. \$18.50

No. 46A-16B PATCH CORD: Same as No. 46A-16A except six feet in length. . . . \$25.50

No. 46A-95A PANEL JACK: Special low capacity panel jack designed for 200-ohm cable. Mates with Nos. 46A-16A and 46A-16B Patch Cords or No. 46A-95B Cable Plug. Requires $\frac{1}{8}$ inch diameter mounting hole \$7.50

No. 46A-95B CABLE PLUG: Low capacity plug designed for use with 200-ohm cable. Mates with No. 46A-95A Panel Jack and with No. 46A-95E Connector Sleeve. \$7.50

No. 812-52 CABLE: Special 200-ohm cable available in lengths to meet customer requirements. per foot, \$1.75

No. 46A-95C 50-OHM ADAPTER: Provides a type N connection for coupling a 50-ohm transmission line to the input of a Model 460A or 460B amplifier. Includes a terminating resistor. \$15.00

No. 46A-95E CONNECTOR SLEEVE: Provides for joining two No. 46A-95B Cable Plugs in order to interconnect two lengths of 200-ohm cable \$7.50

No. 46A-95F ADAPTER: For connecting Nos. 46A-16A or 46A-16B patch cords to 5XP-tube \$10.00

No. 46A-95G ADAPTER: For connecting Nos. 46A-16A or 46A-16B patch cords to terminal plate of current Tektronix type 511 oscilloscope \$12.50

Data subject to change without notice.

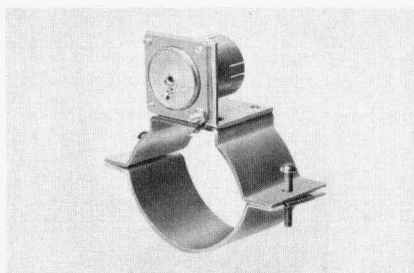

Figure 7. -hp- 46A-95F Adapter.

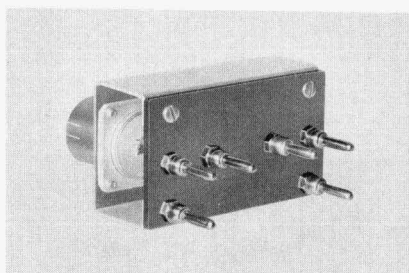

Figure 8. -hp- 46A-95G Adapter.